

Dimension: (Unit: mm)

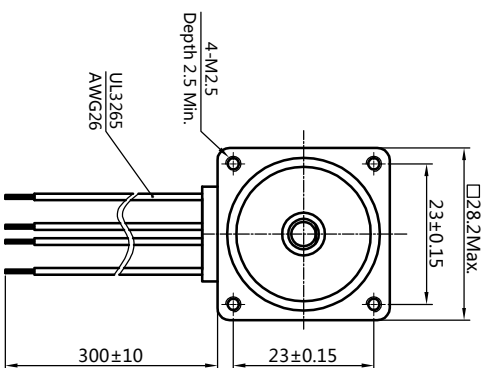

Motor Conenctions:

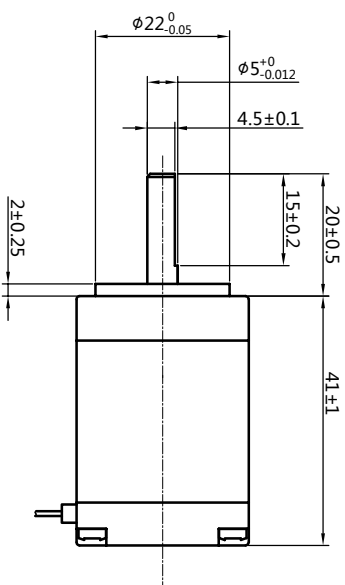
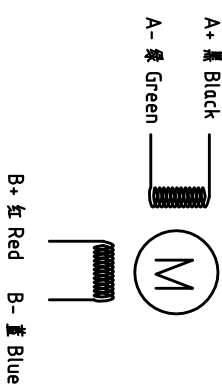

版本 Rev	日期 Date	变更文件号 ECU NO.	变更内容 Revisions	设计 By
V1.0			初版	王洪林

Common Rating

Step angle	1.8°
Position accuracy	1.8±0.09°
Dielectric strength	500VAC 1min
Insulation resistance	100MΩhm(500VDC)
Insulation class	B
Temp rise(Max)	80K
Radial play	Max:0.02mm(load 4.50g)
Axial play	Max:0.08mm(load 900g)

Specification:

Current/phase	1.2 A (Peak Current)
Voltage	1.7V
DC Resistance/phase ±10%	1.8 Ω
Inductance/phase ±20%	1.6 mH
Holding torque	0.1 N·M
Inertia	0.13 kg·cm ²
Weight	0.16 kg

设计 Designed	王洪林	日期 Date	2018.01.22	材料 Material				深圳市雷赛智能控制股份有限公司 SHENZHEN LEADSHINE TECHNOLOGY CO., LTD.
审核 Checked	刘佩峰	2018.01.22		第一角画法 First angle projection				名称 Title
批准 Approved	田天胜	2018.01.22		重量/比例 Weight/Scale				混合式步进电机
图号 Part No.				共 1 套 第 1 套 Sheet 1 of 1	图号 DWG. NO.			28CM010